

Infrared Thermopile Modules TSEV01 Overview

Version 1.1

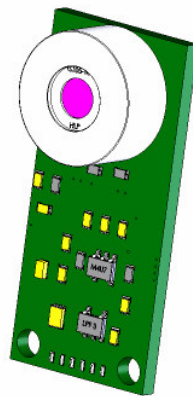

北京赛斯维测控技术有限公司
北京市朝阳区望京西路48号
金隅国际C座1002
电话：+86 010 8477 5646
传真：+86 010 5894 9029
邮箱：sales@sensorway.cn
<http://www.sensorway.cn>

Table of Content

1	History	4
2	Introduction to Thermopile Modules	4
3	Introduction to Thermopile Sensors	5
3.1	Thermopile Function	5
3.2	Anatomy of a thermopile sensor component	6
4	Functional Block Diagram	6
5	Ordering Information	7
5.1	Common Module Types	7
6	General Specifications	8
6.1	Absolute Maximum Ratings	8
6.2	Electrical Requirements	8
6.3	Operational Characteristics	8
7	Thermopile Characteristics	9
8	Optical Characteristics	9
8.1	Measurement Arrangement	9
8.2	General Field of View	9
8.3	Standard TO5 Cap	10
8.4	TO5 Cap with small window Diameter	10
8.5	Thermopile with L5.5mm Lens	10
8.6	Thermopile with L3.9mm Lens	10
9	Filter Characteristics	11
9.1	5 μ Cut-On Filter	11
9.2	8 μ m – 14 μ m Bandpass	11
9.3	Uncoated Silicon Lens (L5mm, L3.9mm)	11
10	Thermopile Sensor Dimension	12
10.1	Standard TO5 Sensor	12

10.2	TO5 Sensor with small Window	12
10.3	L5.5mm Lens	12
10.4	L3.9mm Lens	12
11	Board Dimensions	13
11.1	General Board Dimensions	13
11.2	TP5 Standard Thermopile Sensor	13
11.3	TO5 Sensor with small Window	14
11.4	L5.5mm Lens	14
11.5	L3.9mm Lens	14
12	Sensor Interface (I2C)	15
12.1	Physical Interface Parameters	15
12.2	I ² C Command Reference	15
12.3	Example of Temperature Calculation	15
12.4	Out of Range Indication	15
13	Analog Temperature Output	16
13.1	General	16
13.2	Output Characteristic	16
14	Infrared Temperature Measurement Guide	17
14.1	Testing I ² C Communication	17
14.2	Measurement of Ambient (Sensor) Temperature	17
14.3	Measurement of Object Temperature	18
14.3.1	Typical Object Temperature Measurement Accuracy	18
14.3.2	Field of View	18
14.3.3	Direct Sunlight	19
14.3.4	Emissivity	19
14.3.5	Touching the Sensors Cap	19
15	Additional Information	19

1 History

Ver.	Document name	Date	Purpose	Author
1.0	TSEV01_Overview_V1_0_20071119.doc	19.11.2007	Creation	M. Basel
1.1	TSEV01_Overview_V1_0_20071120.doc	20.11.2007	Update	M. Basel

2 Introduction to Thermopile Modules

A thermopile module is a contact-less temperature measuring system for OEM use based on the detection of infrared radiation.

The systems is equipped with an infrared sensor (thermopile) in front. The thermopile Sensor has to be pointed at the target object of interest.

The basic working principle is:

- Detection of infrared radiation with a thermopile sensor, which turns incoming radiation to an analogue voltage
- Determination of sensor temperature using a thermistor
- Further analogue signal processing and conditioning
- Calculation of ambient and object temperature using a processing unit
- Providing the ambient and objects temperature at digital output bus (I2C) or analogue voltage output

A thermopile module is suitable for a wide range of application where non-contact temperature measurement and high accuracy are required.

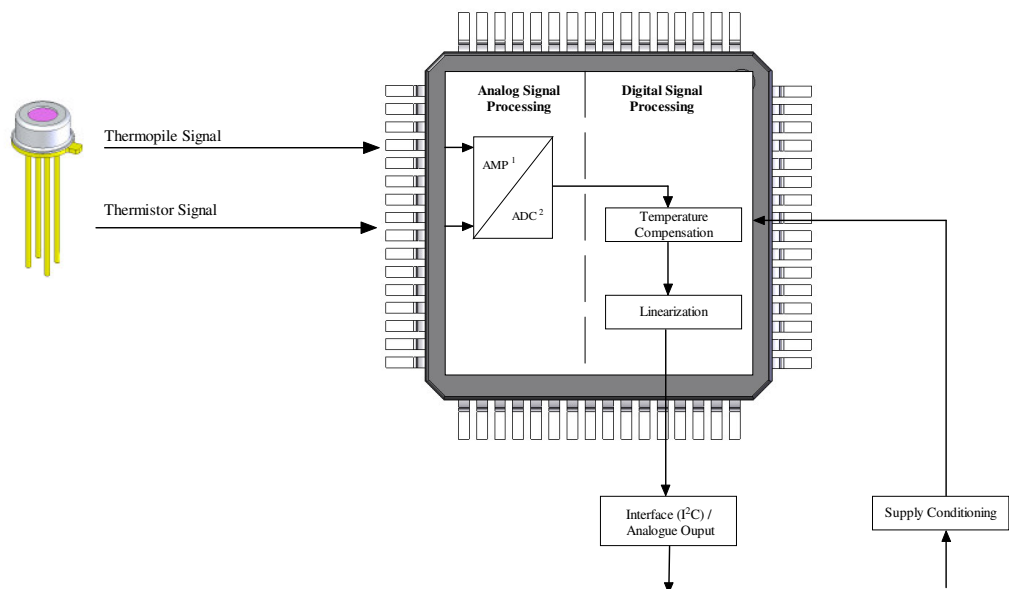

3 Introduction to Thermopile Sensors

Thermopiles are mainly used for contactless temperature measurement in many applications. Their function is to transfer the heat radiation emitted from the objects into voltage output. Major applications are:

- appliances
 - microwave oven
 - clothes dryer
 - automatic cooking
- medical devices
 - ear and fore head thermometer
- automotive applications
 - car climate control
 - seat occupancy
 - blind spot alert
 - black ice detection
- consumer products
 - printer
 - copier
 - mobile phone
- industry applications
 - paper web
 - plastic parts

3.1 Thermopile Function

Any object emits infrared radiation. The radiation power is increasing with growing surface temperatures. Based on this relation, thermopiles measure the emitted power and determine the object's temperature precisely.

Thermopiles are based on the Seebeck effect, which is used since a long time for conventional thermocouples. The application of micromechanics and thin film technology allows the production of miniaturized and cost effective sensor elements.

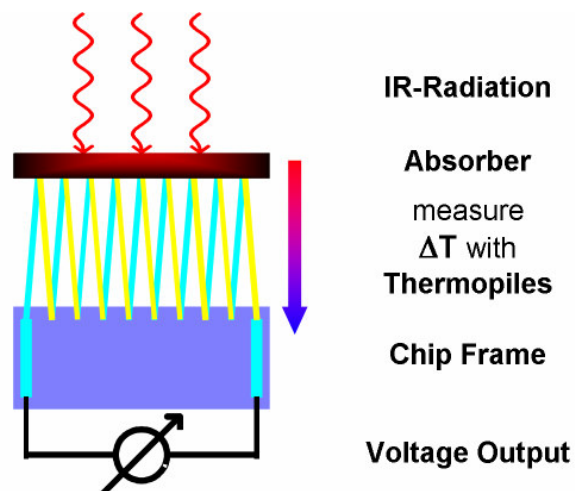

3.2 Anatomy of a thermopile sensor component

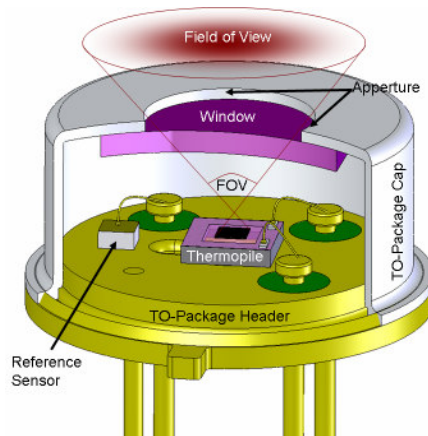

Part	Function
Thermopile Chip	Sensing element, converts radiation into voltage
Reference Sensor	Measures the temperature of the sensor package, i.e. the temperature of the cold contacts
Window	Filter and/or lens: <ul style="list-style-type: none"> defines wavelength range of the component defines together with the thermopile chip and the package the field of view (FOV) provides together with the package hermetic sealing
TO-Package	Cap & Header: <ul style="list-style-type: none"> defines together with the thermopile chip and the package the field of view (FOV) provides together with the window hermetic sealing provides electrical connections of the component

4 Functional Block Diagram

The block diagram below shows the general functional parts. The system contains

- Thermopile sensor
- Amplifier
- MCU for signal processing, ambient temperature compensation and temperature calculation
- I²C interface to provide measurement data to an external controller
- Optional simple analogue voltage output

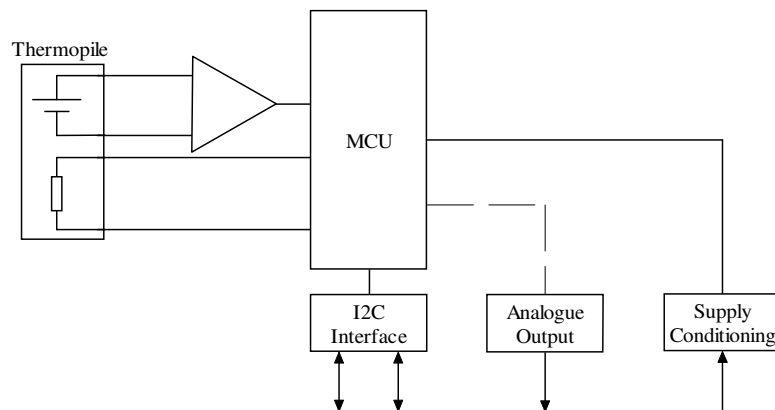

5 Ordering Information

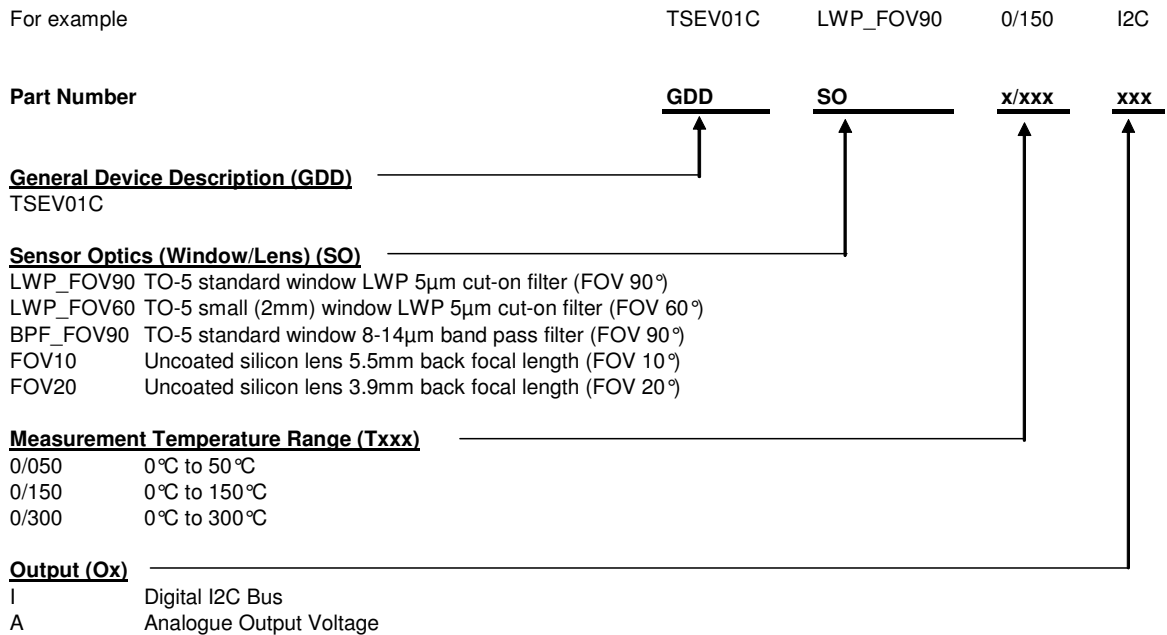

5.1 Common Module Types

Order Code	Sensor Optics	Measurement Range	Output
TSEV01C – LWP_FOV90 – x/xxx – I2C	Standard window with 5µm cut-on filter and 90° FOV	x/xxx	I ² C
TSEV01C – LWP_FOV60 – x/xxx – I2C	Small window with 5µm cut-on filter and 60° FOV	x/xxx	I ² C
TSEV01C – BPF_FOV90 – x/xxx – I2C	Standard window with 8-14µm bandpass filter and 90° FOV	x/xxx	I ² C
TSEV01C – FOV10 – x/xxx – I2C	Integrated uncoated silicon lens (L5.5mm) with 10° FOV	x/xxx	I ² C
TSEV01C – FOV20 – x/xxx – I2C	Integrated uncoated silicon lens (L3.9mm) with 20° FOV	x/xxx	I ² C
TSEV01C – LWP_FOV90 – x/xxx – ANA	Standard window with 5µm cut-on filter and 90° FOV	x/xxx	Analog



北京赛斯维测控技术有限公司

北京市朝阳区望京西路48号

金隅国际C座1002

电话：+86 010 8477 5646

传真：+86 010 5894 9029

邮箱：sales@sensorway.cn

<http://www.sensorway.cn>

6 General Specifications

6.1 Absolute Maximum Ratings

Absolute maximum ratings are limiting values of permitted operation and should never be exceeded under the worst possible conditions either initially or consequently. If exceeded by even the smallest amount, instantaneous catastrophic failure can occur. And even if the device continues to operate satisfactorily, its life may be considerably shortened.

Parameter	Symbol	Conditions	Min	Typ	Max	Unit
Supply Voltage	V_{cc}	Measured versus GND	-0.3		16	V
Operating Temperature	T_{op}		-10		85	°C
Storage temperature	T_{stor}		-40		85	°C

6.2 Electrical Requirements

If not otherwise noted, 25°C ambient temperature, 5V supply voltage and object with $\epsilon = 0.98$ were applied.

Parameter	Symbol	Conditions	Min	Typ	Max	Unit
Field of View	FOV			Depending on sensor selection		°
Spectral Sensitivity	S			Depending on sensor selection		μm
Supply Current	I	Full ambient temp. range,	1	2	4	mA
Digital Output Clock Rate (I^2C)	F_{I2C}			20	50	kHz
Data Output Rate	F_{out}			1		Hz

6.3 Operational Characteristics

If not otherwise noted, 25°C ambient temperature, 5V supply voltage and object with $\epsilon = 0.98$ were applied.

Parameter	Symbol	Conditions	Min	Typ	Max	Unit
Object Temperature Range	T_{obj}		0		300	°C
Ambient Temperature Range	T_{amb}		0		85	°C
Standard Start-Up Time	t_{start}			5		s
Stabilization Time	t_{stab}			3		min
Accuracy offset – prior to thermal stability time	ΔT_{stab}			$\pm 2.5^{(2)}$		%FS
Accuracy tolerance when $10^\circ\text{C} < T_{ambient} < 40^\circ\text{C}$ and after 3 minutes stabilization time	ΔT	$xx < T_{object} < xx$		$\pm 1.5^{(2)}$		%FS
		Outside above range		$\pm 2.5^{(2)}$		%FS

1), 2) The overall accuracy depends on sensor selection and measurement temperature ranges.

7 Thermopile Characteristics

Parameter	Typical	Condition
Absorber Area	0.7×0.7 mm ²	
Resistance of Thermopile	43±8 kΩ	+25 °C
TC of Resistance	-0.06±0.04 %/K	+25 °C → +75 °C
Thermopile Voltage	6.0±1.7 mV	+25 °C, BB +100 °C, DC totally filled field of view
TC of sensitivity	-0.45±0.08 %/K	+25 °C → +75 °C
Noise Equivalent Voltage	30 nV/Hz ^{1/2}	+25 °C
Time Constant	20±5 ms	63%
Ambient Temperature Sensor	NTC	
Resistance	100 kΩ ±5%	+25 °C
β-Value	3955 K ±0.3%	0 °C → +50 °C

8 Optical Characteristics

8.1 Measurement Arrangement

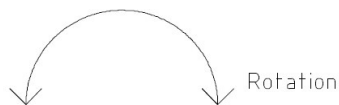
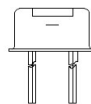

8.2 General Field of View

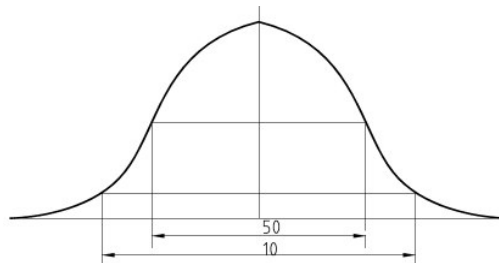

8.3 Standard TO5 Cap

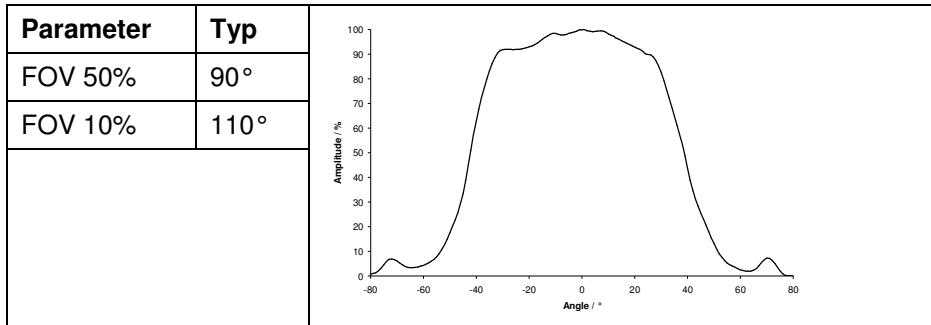

8.4 TO5 Cap with small window Diameter

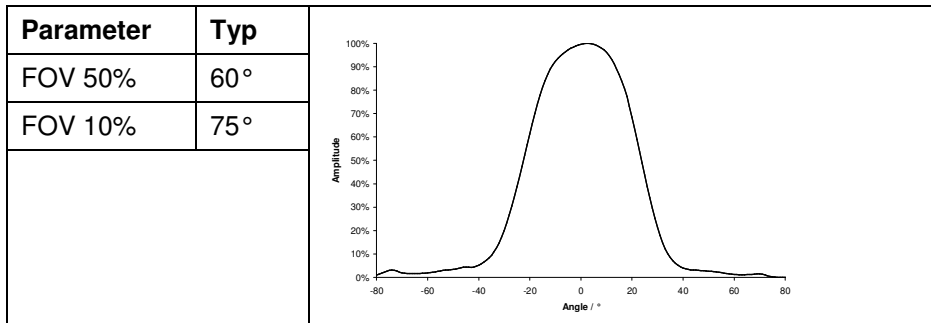

8.5 Thermopile with L5.5mm Lens

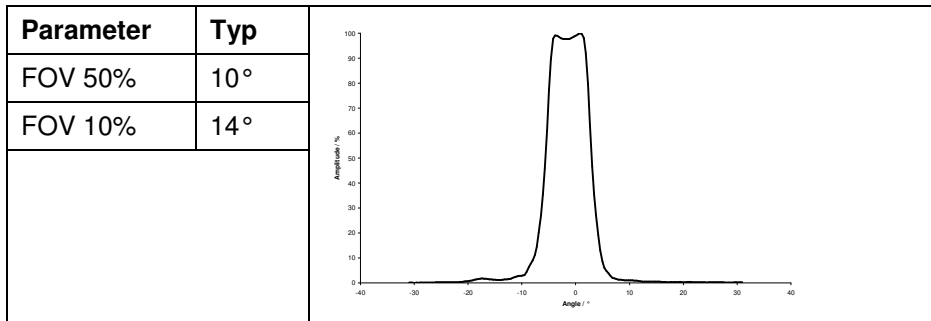

8.6 Thermopile with L3.9mm Lens

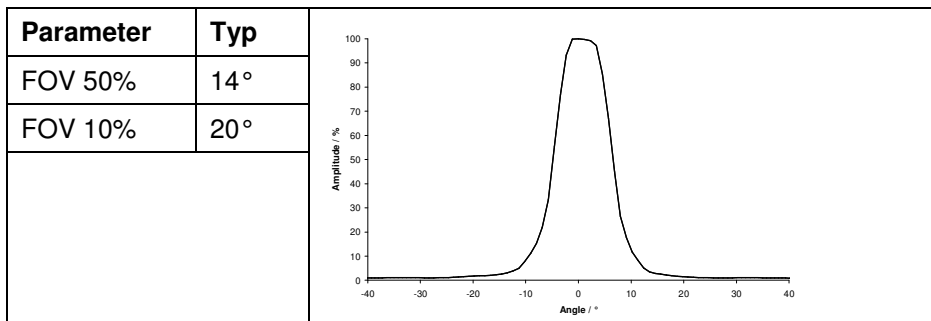

9 Filter Characteristics

9.1 5 μ Cut-On Filter

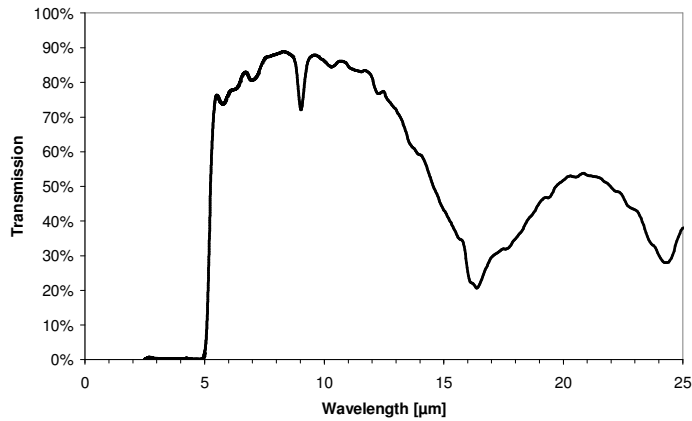

9.2 8 μ m – 14 μ m Bandpass

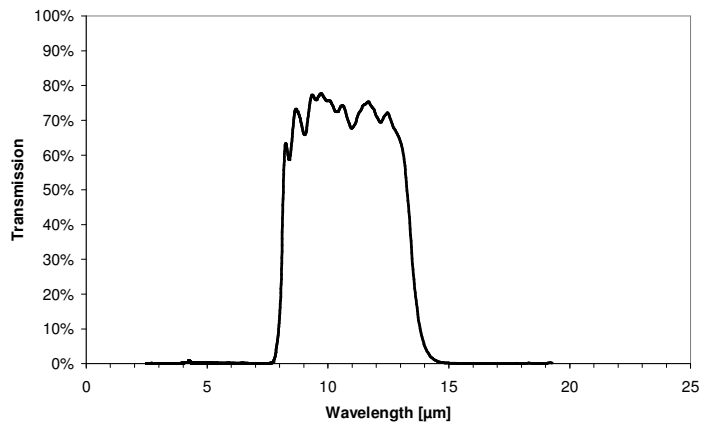

9.3 Uncoated Silicon Lens (L5mm, L3.9mm)

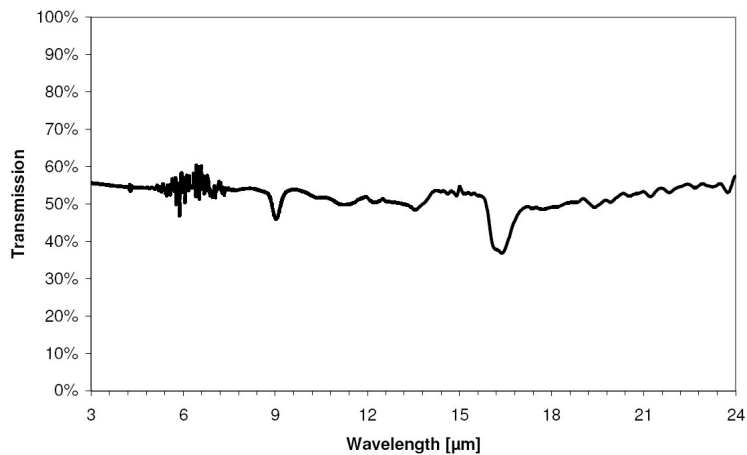

10 Thermopile Sensor Dimension

10.1 Standard TO5 Sensor

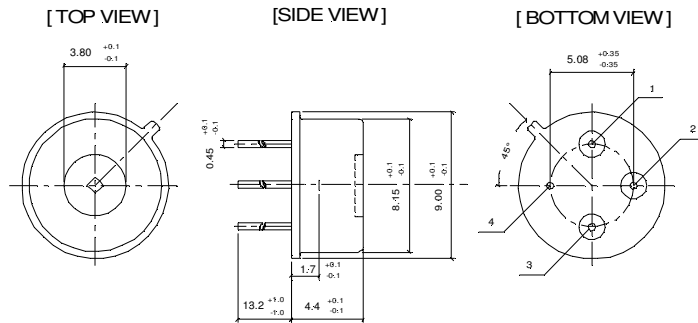

10.2 TO5 Sensor with small Window

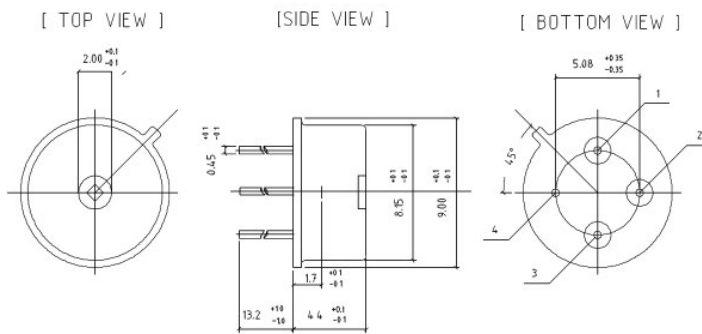

10.3 L5.5mm Lens

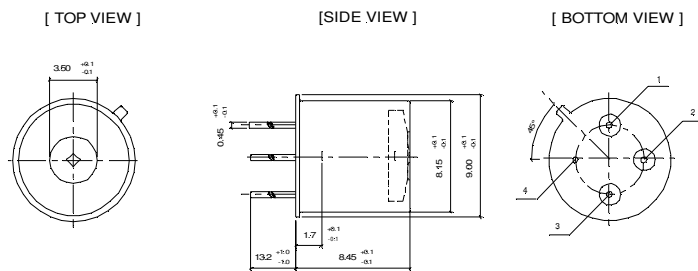

10.4 L3.9mm Lens

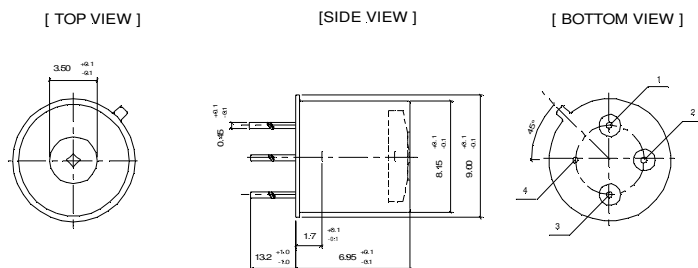

11 Board Dimensions

11.1 General Board Dimensions

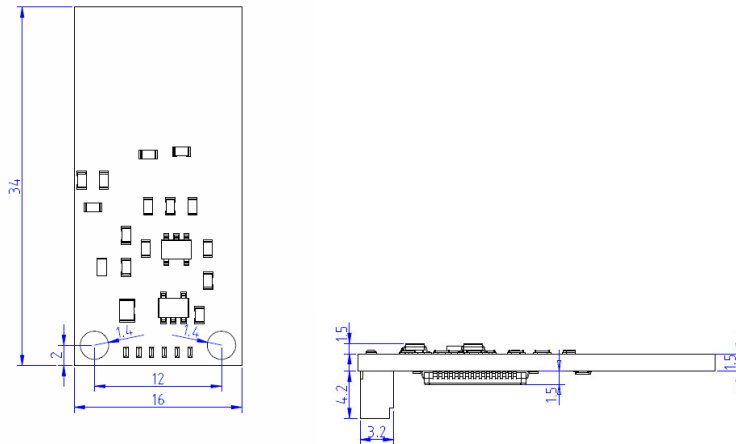

11.2 TP5 Standard Thermopile Sensor

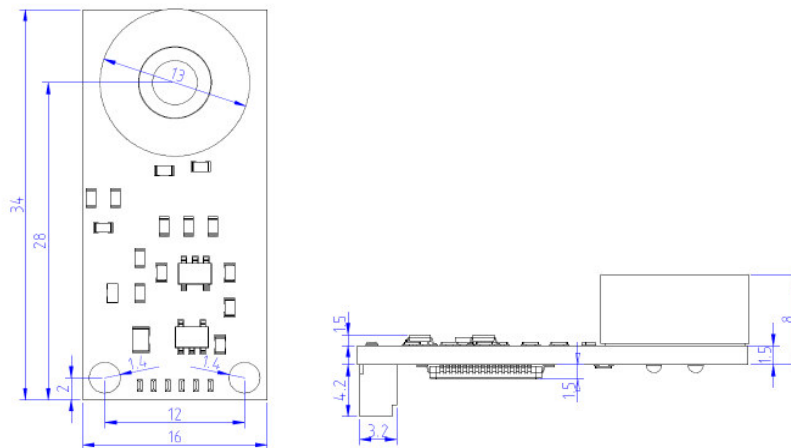

北京赛斯维测控技术有限公司
 北京市朝阳区望京西路48号
 金隅国际C座1002
 电话：+86 010 8477 5646
 传真：+86 010 5894 9029
 邮箱：sales@sensorway.cn
<http://www.sensorway.cn>

11.3 TO5 Sensor with small Window

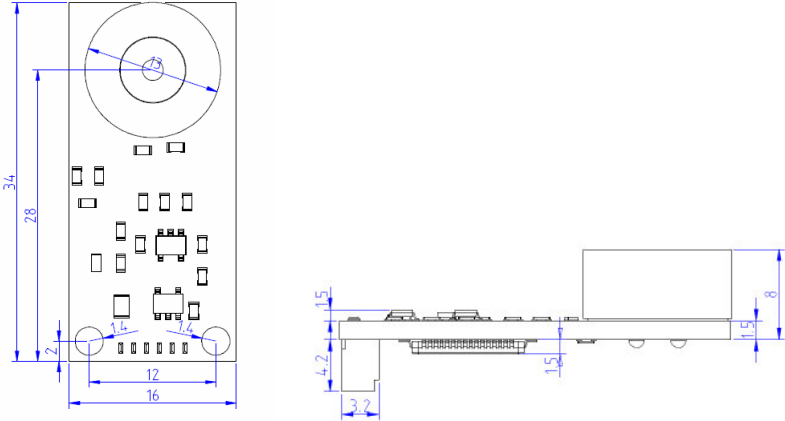

11.4 L5.5mm Lens

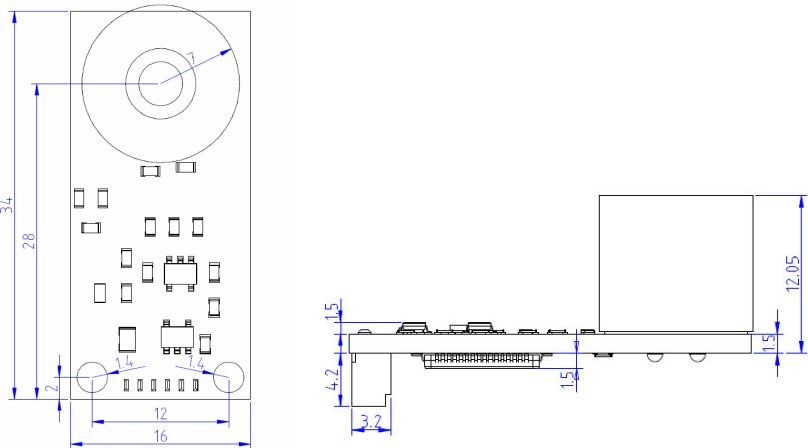

11.5 L3.9mm Lens

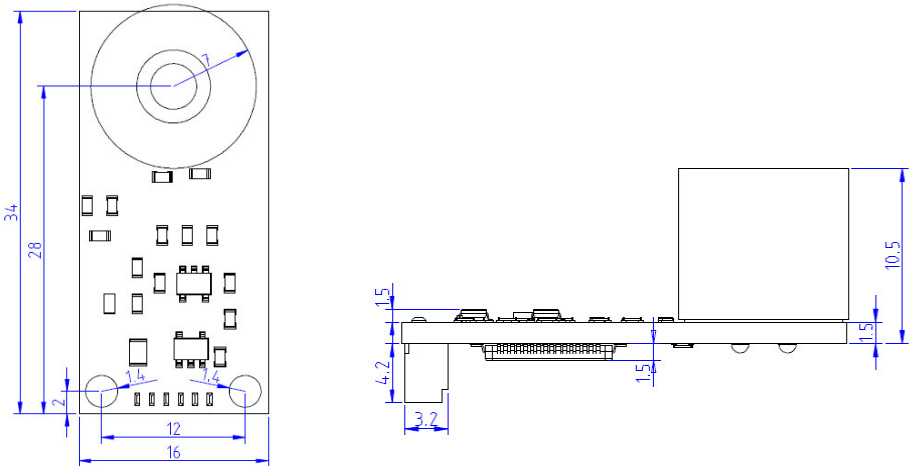

12 Sensor Interface (I2C)

This module is always operating in pure slave modus of a two wire interface similar to I²C. The typical baud rate of this device is 20kBit/s. The supported address length is seven bits. The I²C slave address is 54h.

12.1 Physical Interface Parameters

Parameter	Min	Typical	Max	Unit
Baudrate	10	---	50	kBit/s
Address length	---	7	---	Bit
Address (standard)	---	54h	---	---
Input High Level	2	---	3.6	V
Input Low Level	---	---	1	V
Output High Level	2.5	---	---	V
Output Low Level	---	---	1	V

12.2 I²C Command Reference

Please refer following table for I²C commands to read object temperature and ambient temperature. Both values are transmitted in hundredth of degrees.

Command	Description	Reply	Bytes
0xB6	Read object temperature	Object temperature in hundredth of degree	2
0xB5	Read ambient temperature	Ambient temperature in hundredth of degree	2

12.3 Example of Temperature Calculation

For reading object temperature send: 0xB6

Return values i.e.: Byte(0) = 0x0E, Byte(1) = 0xAA

Temperature $T_{obj} = (256 * \text{Byte}(0) + \text{Byte}(1)) / 100 = (256 * 14 + 170) / 100 = \underline{37,54^{\circ}\text{C}}$

12.4 Out of Range Indication

In case of ambient or object temperature over exceeding specified temperature ranges temperature outputs showing following data:

Command	Description	Reply	Bytes
0xB6	Object temperature > XX°C	0xFFF0	2
0xB6	Object temperature < 0°C	0xFFF1	2
0xB5	Ambient temperature > 85°C	0xFFFF	2
0xB5	Ambient temperature < 0°C	0xF000	2



北京赛斯维测控技术有限公司
 北京市朝阳区望京西路48号
 金隅国际C座1002
 电话：+86 010 8477 5646
 传真：+86 010 5894 9029
 邮箱：sales@sensorway.cn
<http://www.sensorway.cn>

13 Analog Temperature Output

13.1 General

Special versions are containing an analogue output which indicated the measured object temperature.

13.2 Output Characteristic

The output voltage indicates the object temperature measured by the sensor module. The voltage level swings from 0V to 3V. The maximum swing (3V) is correlated to the maximum measurement temperature (ie. 100°C).

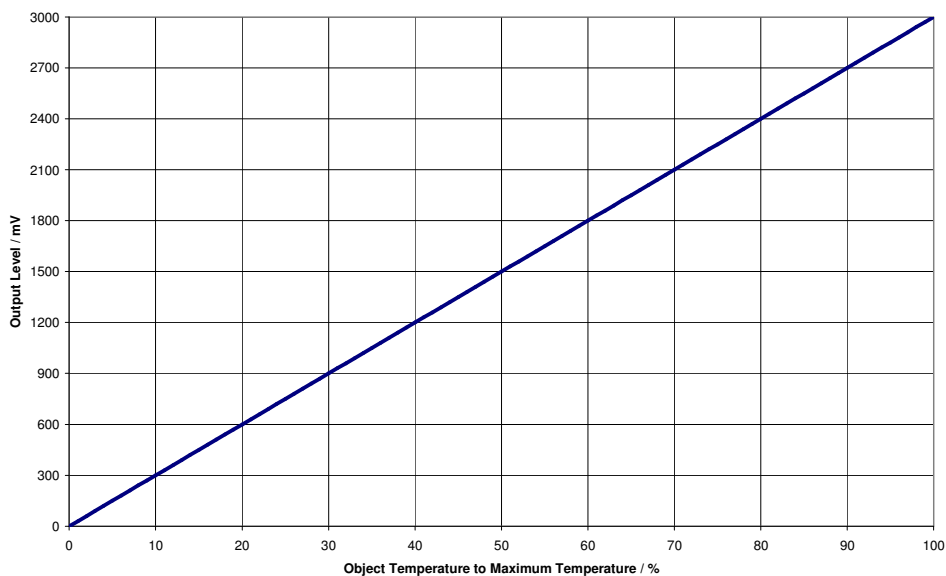

北京赛斯维测控技术有限公司
 北京市朝阳区望京西路48号
 金隅国际C座1002
 电话：+ 86 010 8477 5646
 传真：+ 86 010 5894 9029
 邮箱：sales@sensorway.cn
<http://www.sensorway.cn>

14 Infrared Temperature Measurement Guide

14.1 Testing I²C Communication

Before performing of measurement, user may check valid I²C communication between Master system and the thermopile sensor unit.

Therefore request ambient temperature measurement and check if the transmitted value correspond to the actual room temperature.

Next step is to test object temperature measurement. Point the thermopile sensor to any constant temperature surface (i.e. room wall). The measured object temperature has to be close to the ambient temperature measured before.

14.2 Measurement of Ambient (Sensor) Temperature

A thermistor is integrated in the thermopile sensor due to the need of ambient temperature compensation. This thermistor is measuring the sensors temperature. Therefore, after some settling time, the sensor temperature matches the actual room temperature.

A typical curve of sensor temperature measurement accuracy is shown below.

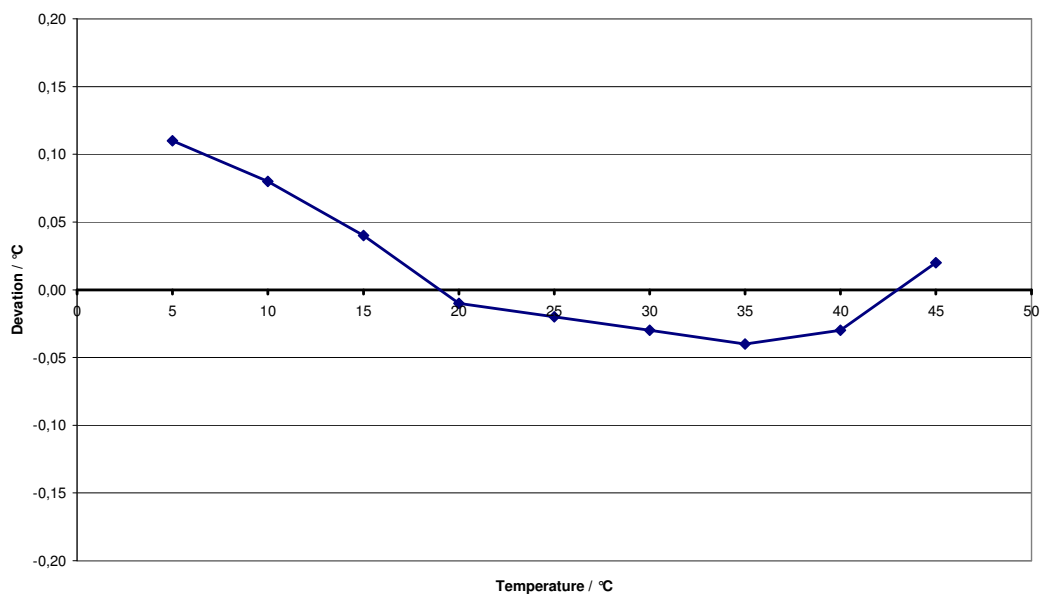

北京赛斯维测控技术有限公司
 北京市朝阳区望京西路48号
 金隅国际C座1002
 电话：+86 010 8477 5646
 传真：+86 010 5894 9029
 邮箱：sales@sensorway.cn
<http://www.sensorway.cn>

14.3 Measurement of Object Temperature

To achieve reliable and accurate object temperature measurements, user has to comply to some advice when it comes to handle with thermopile sensors.

- Field of View
- Valid results are available at 3 seconds after pointing at object of interest.
- Avoid scratches or contamination of window surface.
- Avoid touching the cap of the sensor

14.3.1 Typical Object Temperature Measurement Accuracy

The measurement results below were recorded at three different object temperatures while performing a ambient temperature ramp.

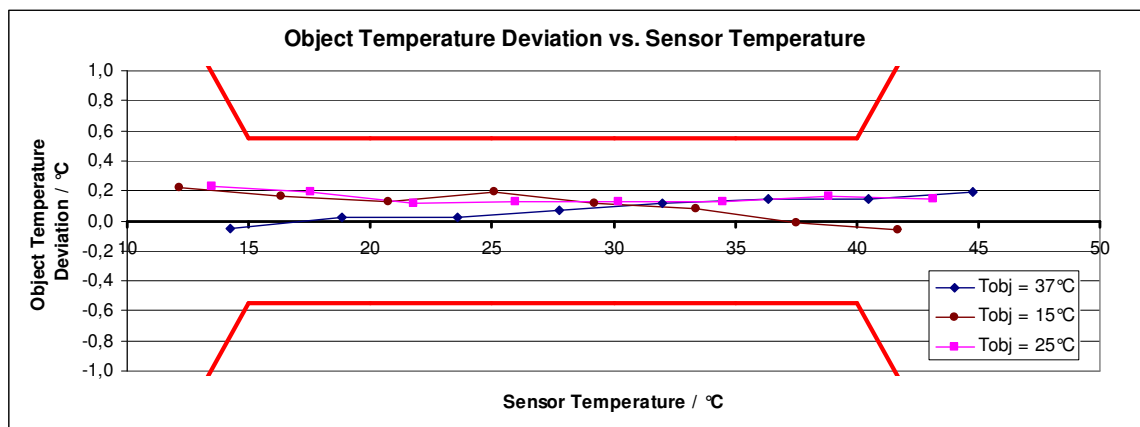

14.3.2 Field of View

The thermopile's field of view has to be directed to the object surface of interest. The distance to the surface or the surface diameter has to be adjusted to insure that the complete sensors field of view is covered by the object.

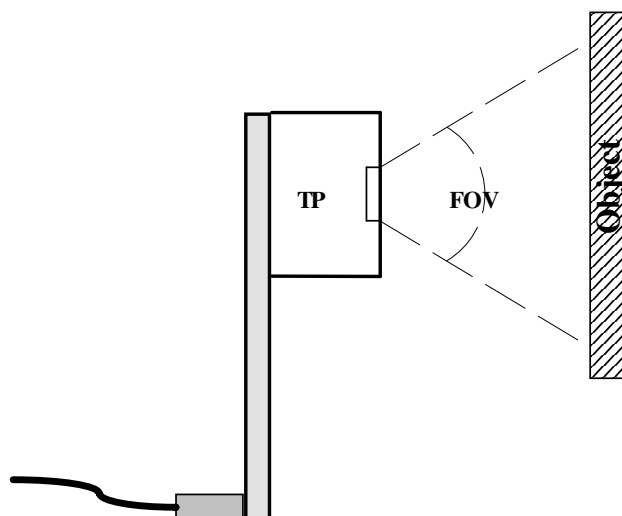

14.3.3 Direct Sunlight

Sun light radiation which is transmitted through a glass window may influence the measurement accuracy. To avoid this, the thermopile sensor is equipped with a long wavelength filter. Due to not ideal filter characteristics a small portion of radiation will be added to the radiation of the object. In case of direct sunlight exposure this error can be up to +0.2°C.

14.3.4 Emissivity

Every object is transmitting infrared energy in dependence to its temperature. The emissivity is the ratio of the radiated power by an object to the radiation of an ideal black body. Common materials like liquids, clothes, human skin, foods have emissivity factors >0.90 and therefore they can be measured very accurately without adopting the sensors specification.



The internal emissivity correction algorithm may be adjusted to customer application while calibration process.

14.3.5 Touching the Sensors Cap

User should avoid touching the sensors cap. The sensor system is equipped with a special mechanism to decrease impacts of heating or cooling on measurement accuracy. Even so there will still be a measurement deviation for some seconds after changing the sensors temperature rapidly.

15 Additional Information

Manufacturer company:	HL-Planartechnik GmbH Hauert 13 D-44227 Dortmund
Phone	+49 (0)231/ 9740-0
Fax	+49 (0)231/ 9740-20
URL	www.hlplanar.com
Mail	mailto:service@hlplanar.de



北京赛斯维测控技术有限公司
北京市朝阳区望京西路48号
金隅国际C座1002
电话：+ 86 010 8477 5646
传真：+ 86 010 5894 9029
邮箱：sales@sensorway.cn
<http://www.sensorway.cn>